

PRODUCT BRIEF

key features

MM6108 OVERVIEW

IEEE 802.11ah Sub-1 GHz 1/2/4/8 MHz BW MAC/PHY/Radio Wi-Fi HaLow SoC



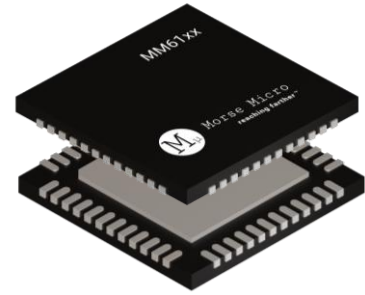





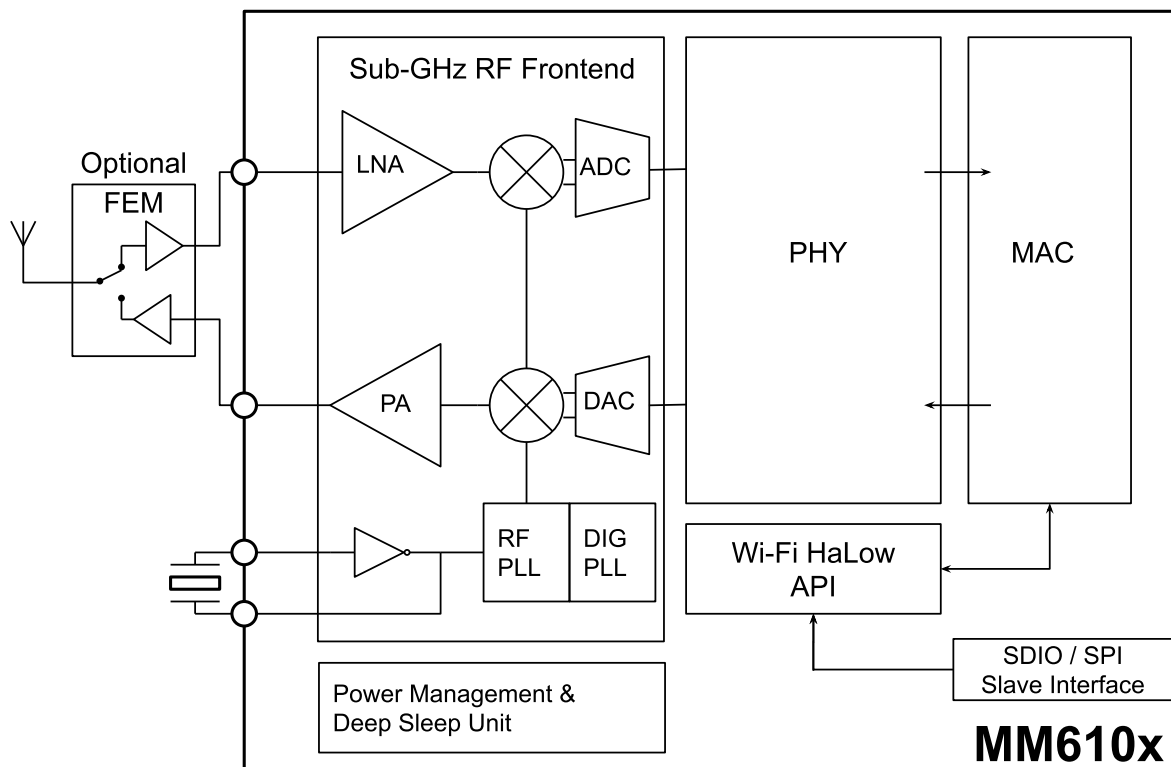

Morse Micro provides a complete Wi-Fi HaLow connectivity solution. The MM6108 SoC is a single-chip solution, including Radio, PHY, and MAC sections designed in accordance with the IEEE 802.11ah standard, supporting data rates up to 32.5 Mbps. The standard provides for operation in the sub 1GHz license-exempt RF bands. The Radio in the MM6108 supports programmable operation in these bands, worldwide, between 850MHz and 950MHz.



The RF interface for the MM6108 includes the option to use either the on-chip amplification for typical low-power, low-cost devices, or in conjunction with an external PCB-mount power amplifier (PA) or Front-End Module (FEM) for Ultra-Long-Reach applications. The RF receiver features a high linearity LNA, making the use of external filters unnecessary in many applications.

Battery-operated applications are supported by a combination of features in the MM6108. The IEEE 802.11ah standard provides for extended sleep times of battery-operated STA client devices, with longer durations than other prior IEEE 802.11a/b/g/n/ac generations.



-  Single-Chip IEEE802.11ah Wi-Fi HaLow Transceiver for Low-Power, Long-Reach IoT
-  Radio supporting worldwide Sub 1GHz bands
-  Single-stream max data rate of 32.5 Mbps
-  On-chip Power Amplifier, External FEM option
-  6 x 6 x 0.85 mm QFN48 Package
-  Power Management Unit (PMU) supporting Ultra-Low-Power operation
-  SDIO 2.0 and SPI Host interface Options
-  GPIO/UART/I2C/PWM Peripheral Options
-  WPA3 Security
-  1/2/4/8 MHz Channel Bandwidth

Wi-Fi HaLow Modulation and Coding Scheme

MCS Index	Modulation Scheme	Coding Rate	Phy Rate (kbps) per BW			
			1 MHz	2 MHz	4 MHz	8 MHz
10	BPSK	1/2 x 2	167	N/A		
0	BPSK	1/2	333	722	1500	3250
1	QPSK	1/2	667	1444	3000	6500
2	QPSK	3/4	1000	2167	4500	9750
3	16-QAM	1/2	1333	2889	6000	13000
4	16-QAM	3/4	2000	4333	9000	19500
5	64-QAM	2/3	2667	5778	12000	26000
6	64-QAM	3/4	3000	6500	13500	29250
7	64-QAM	5/6	3333	7222	15000	32500

For Internet of Things (IoT) and Machine-to-Machine (M2M) applications:

- Surveillance Cameras and Sensors
- Cloud Connectivity
- Low-power Sensor Networks
- Building Automation Systems (BAS)
- Asset Tracking and Management
- Machine Performance Monitors and Sensors
- Building Access Control & Security
- Drone Video and Navigation Communications
- Rural Internet Access
- Utility Smart Meter and Intelligent Grid
- Proximity Sensors
- Industrial Automation Controls
- Smart Home Automation
- BT/ZigBee(™)/Z-Wave(™) to Wi-Fi HaLow Gateways
- Wi-Fi to Wi-Fi HaLow Bridges
- Wi-Fi HaLow Client Adapters/Dongles
- Smart City Network

Morse Micro pty. ltd. Corporate Headquarters
Level 8, 10-14 Waterloo Street, Surry Hills, NSW 2010, Australia

USA: +1.949.501.7080
Australia: +61.2.905.45922
China: +86.571.229.30277
E-mail: sales@morsemicro.com
www.morsemicro.com



**contact
us**

